



WAFER CHECK VALVE

CV-122 Series

ALLOWABLE PRESSURE : 10bar

SIZE : ND40mm-DN1200mm



ISO 9001 - 2000



0038

www.valuevalves.com

CV-122 Double plate check valve is a general purpose and one way flow valve that is stronger, lighter and more reliable than conventional swing check valve. Due to lighter in weight and short face-to-face dimension, it's very easy to be maintained and installed between flanges. Inner parts assembled by two semicircular springs and plates, which pinned to the body. Normally close by spring action and open by fluid pressure. Due to very quick reaction of spring cycle, it could protect piping from water hammer.

SIZE: 40mm-1200mm

PRESSURE TESTING IS ACCORDING TO ISO 5208

Seat testing: 11bar(160psi)

Body testing: 15bar(220psi)

END CONNECTIONS:

BS10 TABLE "E", ANSI 150Lb

ISO-PN10, JIS 10K

Comparison of the shape with conventional swing check valve

Small and Light
Quick reaction
Vertical and Horizontal
Bubble tight

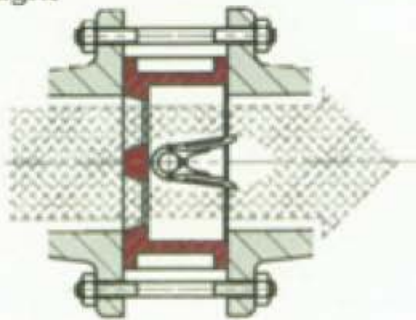

Large and Heavy
Slow reaction
Horizontal installation
Leakage allowable

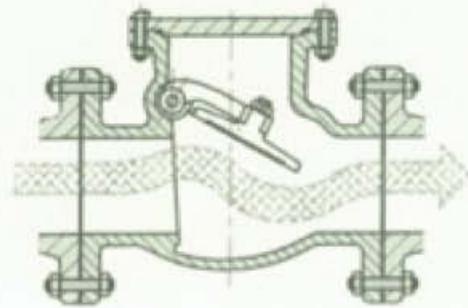

Precautions In Piping

- Lay pipes so that the cast direction of wafer Check body corresponds with the flow direction. (Fig.1)

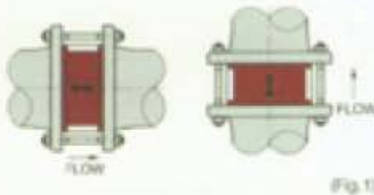

(Fig.1)

- It can be installed in vertical piping.
- In horizontal piping, set the rib of wafer Check vertically. (Fig.2)



(Fig.2)

- Use an extension tube between wafer Check and the butterfly valve. Never connect wafer Check to the valve directly. (Fig.3)

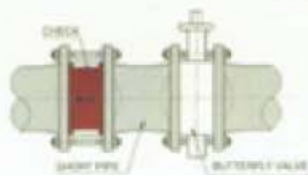

(Fig.3)

- Avoid entering the end of a tube or gasket within the operating area of a radius of the wafer Check plate. (Fig.4)



(Fig.4)

- Never mount a reducer just in front of or behind wafer Check. Leave a space of 5 times the valve diameter (5D) or more. (Fig.5)

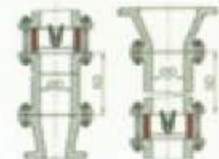

(Fig.5)

- When installing wafer Check near an elbow, leave a space as large as possible between an elbow and wafer Check and be sure that the plate is stressed evenly. (Fig.6)

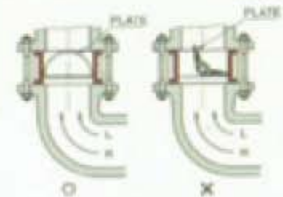

(Fig.6)

- When installing wafer Check at a pump outlet, leave a space of at least 6 times the valve diameter (6D) and be sure that the plate is evenly stressed by fluid. (Fig.7)

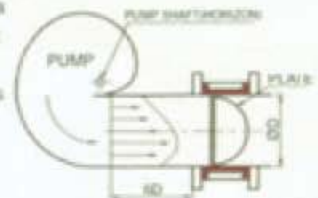

(Fig.7)

- Consult us when flow velocity of liquid exceeds 3m/sec.
- Seat leakage may occur when pressure difference is 0.02Mpa (0.2kgf/cm²) or below.

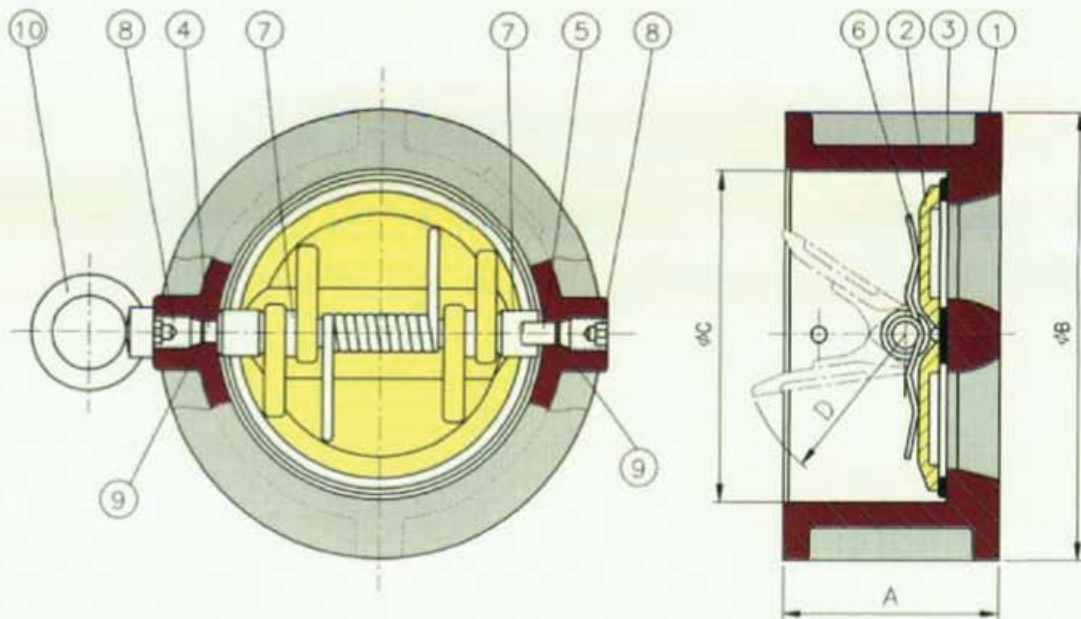

DIMENSIONS					
SIZE (mm)	A	B	C	D	WEIGHT (kg)
40	43	96	72	P25	1.5
50	43	98	66	P29	1.6
65	46	110	80	P36	1.9
80	64	128	100	P44	2.7
100	64	156	112	P53	4.2
125	70	187	135	P65	6.8
150	76	213	160	P77	10.7
200	89	267	210	P102	17.2
250	114	328	260	P127	28.7
300	114	375	310	P152	33.0
350	127	415	360	P170	71.0
400	140	482	410	P220	99.0

DIMENSIONS					
SIZE (mm)	A	B	C	D	WEIGHT (kg)
450	152	530	460	P225	118
500	152	580	510	P250	180
550	219	660	559	P264	228
600	222	718	610	P292	549
650	279	772	660	P312	579
700	321	832	711	P337	580
750	330	883	762	P365	700
800	356	940	813	P397	800
900	387	1048	914	P440	1000
1000	419	1162	1016	P495	1065
1050	432	1219	1067	P527	1260
1200	524	1384	1219	P603	2055

No.	NAME	MATERIALS	SPECIFICATION		REMARKS
			JIS	ASTM	
1.	BODY	CAST IRON	FC200	A126 ClassB	
		DUCTILE IRON	FCD400	A395	
2.	PLATE	BRONZE	BC6	B62	
		STAINLESS STEEL	SCS13	A351CF8	304
			SCS14	A351CF8M	316
3.	SEAT	NBR(NITRILE)			-10°~80°C(14°~176°F)
		EPDM			-20°~120°C(-4°~248°F)
4.	HINGE PIN	STAINLESS STEEL	SUS304	A182F304	
5.	STOP PIN	STAINLESS STEEL	SUS304	A182F304	
6.	SPRING	STAINLESS STEEL	SUS304	A182F304	
7.	BUSHING	TEFLON			
8.	SET BOLT	STEEL	SCM3		
9.	PACKING	NBR (NITRILE)			
10.	EYE BOLT	FORGING STEEL	SF40A		FOR 5" AND LARGER

Cv Value and Spring Action

SIZE (mm)	Cv	mmAq
50	55	300
65	85	300
80	145	250
100	290	200
125	460	150
150	800	150
200	1550	140
250	2800	140
300	4100	130

SIZE (mm)	Cv	mmAq
350	5350	130
400	8250	100
450	10550	70
500	14500	70
600	24000	60
800	48000	50
900	63000	40
1050	91000	35
1200	125000	30

Note:

- The pressure-drop corresponding to the spring action, is referred to the normal torque type.
- Cv=The number of U.S. gallons/minute that will result in 1 psi pressure lose across the valve at temp of 25°C.
- Cv=1.17Kv
Where the Kv value denotes the rate in m³/Hr for water at 25°C flowing under pressure differential 1 Kg/cm².

PRESSURE DROP-FLOW RATE in wafer rubber check valves

(Graph for water in normal conditions)

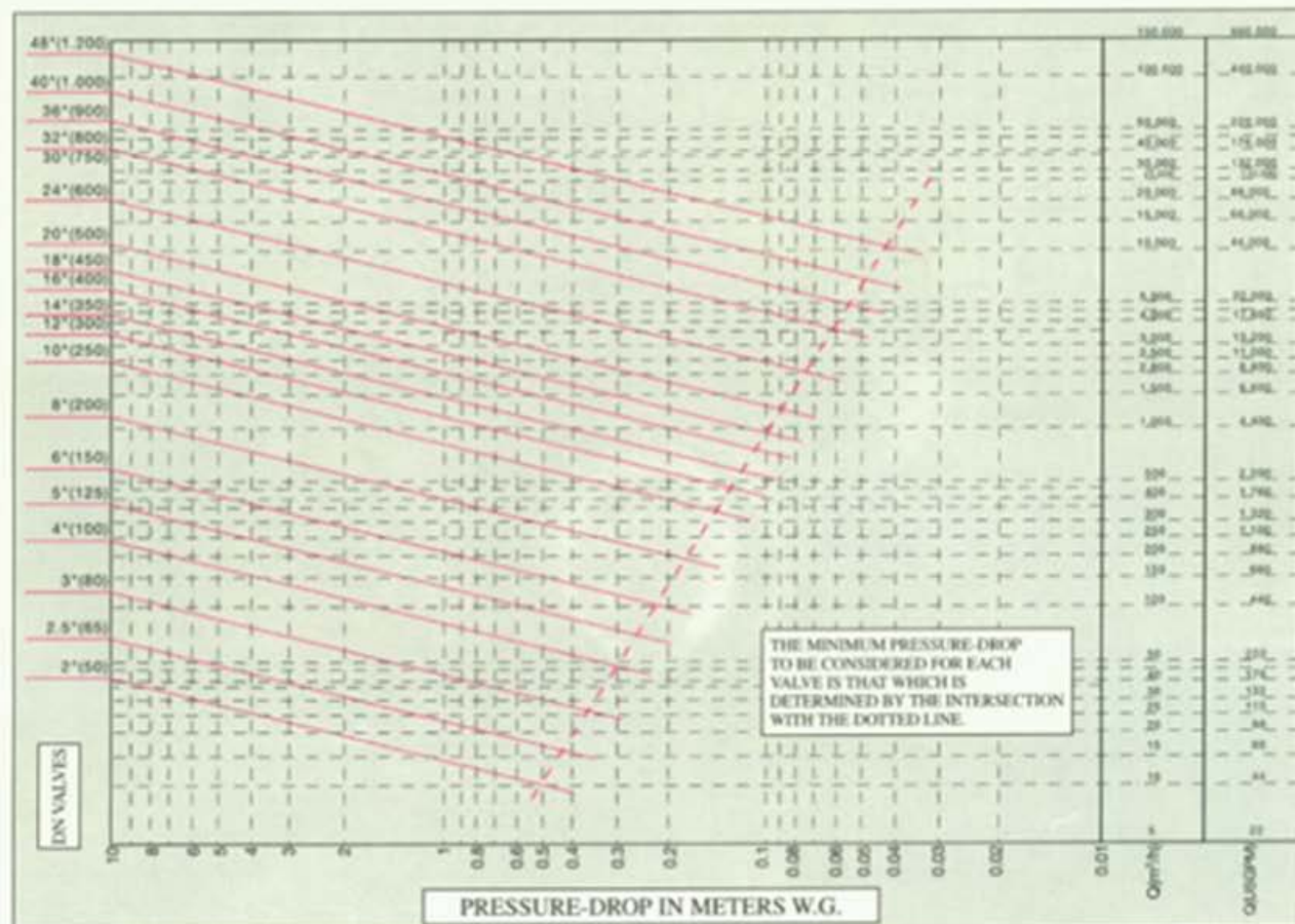

捷流閥業股份有限公司
VALUE VALVES CO., LTD

ISO 9001 APPROVED

蝶型閥・控制閥・雙瓣止回閥
MANUFACTURE, EXPORTER & IMPORTER OF
BUTTERFLY VALVE CONTROL VALVE
WAFFER CHECK VALVE
P/N: 6700X

公司：台北縣土城區236土城工業區中山路9號
No.9, CHUNG SHAN RD., TU-CHENG INDUSTRIAL
DISTRICT, TAIPEI HSIEN, TAIWAN 236, R. O. C.
TEL: (02)2269-8000 FAX: (02)2268-6600
FACTORY/TEL: (02)2268-5881 FAX: (02)2268-1434
<http://www.valuevalves.com>
e-mail: value88@ms14.hinet.net